

# HomeSafe Security Panel

User's Manual

**5400 & 5400/16CB**



# CONTENTS

Features .....	3
Introduction .....	4
Keypad.....	5
Keypad indicators .....	6
OPERATION.....	7, 8
Arming .....	9
Disarming.....	10
Monitor mode .....	11
Keypad panic .....	12
Keypad duress .....	12
Keypad medical alarm .....	13
Keypad fire alarm.....	13
Excluding zones.....	14
View memory .....	15, 16
TEMPORARY DAY ZONES.....	17, 18
PROGRAMMING.....	19
Programming options table .....	20
User code programming .....	21
Entry/exit timer programming.....	22
Telephone number programming .....	22
Central station monitoring .....	23
Audible monitoring .....	24
Remote operation by telephone .....	25, 26
Troubleshooting .....	27
Installation record .....	28
OPERATION SUMMARY.....	29

## 5400 AND 5400/16CB FEATURES

- 8 (5400) or 16 (5400/16CB) alarm zones.
- Supports up to 3 remote LCD or LED keypads.
- 56 user codes can be programmed to operate by keypad PIN, radio key or access card.
- Optional radio interface for fully integrated wireless security.
- Programmable two area partitioning can split the panel into two independent areas plus a common area.
- Monitor mode allows partial arming, (eg, perimeter security overnight).
- Day mode allows daytime monitoring of fire doors, coolrooms etc.
- Temporary Day zone feature allows easy enabling/disabling of Day mode.
- Keypad panic feature.
- Two button arming feature.
- Fire alarm feature with different siren tones.
- Highly flexible zone to output mapping.
- Onboard Vibration Sensor Analyser with programmable sensitivity. When used with the compatible vibration system.
- Siren chirp and strobe flash on arming with radio key.
- Quiet chirps option on arm/disarm by radio key.
- True Dynamic Battery Test actively tests the battery under load every hour.
- 4 programmable auxiliary outputs.
- Automatic reset fuses.
- Programmable siren/reset lockout.
- 30 event memory from keypad.
- Standard defaults to suit most applications.
- Easy programming by keypad or 5400/S2 software.
- All programming data is permanently stored in a non-volatile memory.
- All inputs and outputs are heavily protected against lightning and high voltage supply transients.
- Optional output expander.

### DIALLER

- Full remote upload/download by PC and suitable type of modem using 5400/S2 software.
- Remote control of outputs by telephone.
- Arm/disarm remotely by telephone.
- Contact ID format for central station monitoring. Supports two 14 digit phone numbers plus one “follow me” number for audible monitoring.
- Audible format feature.
- Phone line monitoring (activates output).
- Dialler ‘listen in’ option for installers.
- Auto test calls.
- Pulse or DTMF dialling.
- True dial tone detection.

## INTRODUCTION

The Clipsal 5400 and 5400/16CB microcomputer based 8 or 16 zone control panel is the heart of your security system to which all your detection devices connect.

Each zone of the panel can be connected to one or more detection devices to protect separate rooms of your premises.

Detection devices may be wired to the panel or you can use optional wireless detectors.

Passive Infra-Red motion detectors (PIRs) are used to detect motion of people or animals. Pet Aware motion detectors can ignore pets and still detect people. Reed switches are fitted to windows and doors to detect opening. Vibration sensors can be used to detect glass breakage or forcing of windows or doors.

Normally a zone is considered sealed. Activation of a detection device will cause the zone to be unsealed and may cause an alarm.

Detectors such as fire detectors and panic buttons must be able to generate an alarm at all times regardless of the panel setting. A zone with this assignment is called a 24 Hour zone.

Some detection devices may be required to generate an alarm or warning only when the panel is disarmed. A zone with this assignment is called a Day zone.

Before leaving the premises you must "arm" (turn on) the panel. After arming, the panel will ignore detectors during the Exit Delay Time to allow you to exit without triggering an alarm.

The system can be armed and disarmed using the keypad supplied or by optional Radio Keys or Access Cards or Fobs.

When you enter the premises the panel will ignore selected zones for the Entry Delay Time and will not alarm unless you fail to disarm the panel during this allowed time.

When an alarm occurs, it can be reset with a user code<sup>1</sup> or by optional Radio Key or Access Card/Fob<sup>2</sup>, otherwise it will reset at the end of Alarm Reset Time. Resetting an alarm stops the sirens and strobe light. If an alarm is not reset the sirens will stop after the programmed time (default is 5 minutes) and the strobe light will stop after 72 hours.

Monitor mode allows you to arm selected zones while others are ignored. Typically, perimeter zones (doors and windows) can be monitored while you are at home.

If you wish to split your alarm system into two areas with access limited to each area by code numbers then area operation is used. Radio keys can also arm and disarm areas.

The control panel housing and the covers over external sirens are protected by tamper switches to detect someone attempting to disable the security system. Activation of these switches will cause an instant tamper alarm.

If there is a problem with a detector, you can exclude the associated zone so that it is totally ignored and cannot generate an alarm. Including the zone will enable it to generate an alarm again.

The control panel is fitted with a rechargeable backup battery to ensure your security system continues to operate if the mains power is interrupted. This control panel automatically tests the battery every hour and whenever you arm/disarm the panel. (Dynamic Battery Test).

All alarms are stored in memory and can be viewed at any time in Memory Mode.

<sup>1</sup> Keypad codes programmed as ARM ONLY will not reset the panel.

<sup>2</sup> Access cards/fobs can reset the panel if the DISARM BY ACCESS CARD option has been enabled by your installer.

The 5400 and 5400/16CB control panels may be supplied with a LCD keypad.

The keypad provides important visual and audible indications and is the main interface for operating and programming the control panel.

**DISPLAY TEST (LCD keypad only)**

To display all the keypad icons press and hold the (E) button for at least 2 seconds. All the icons will be on whilst the (E) button is held down.

Display test can be activated at any time either in operating mode or any program mode.

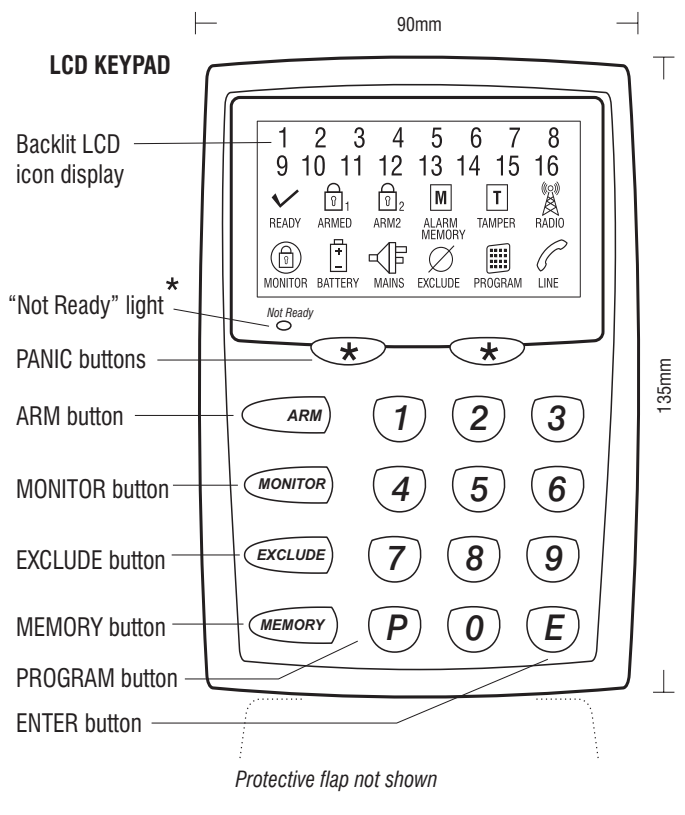
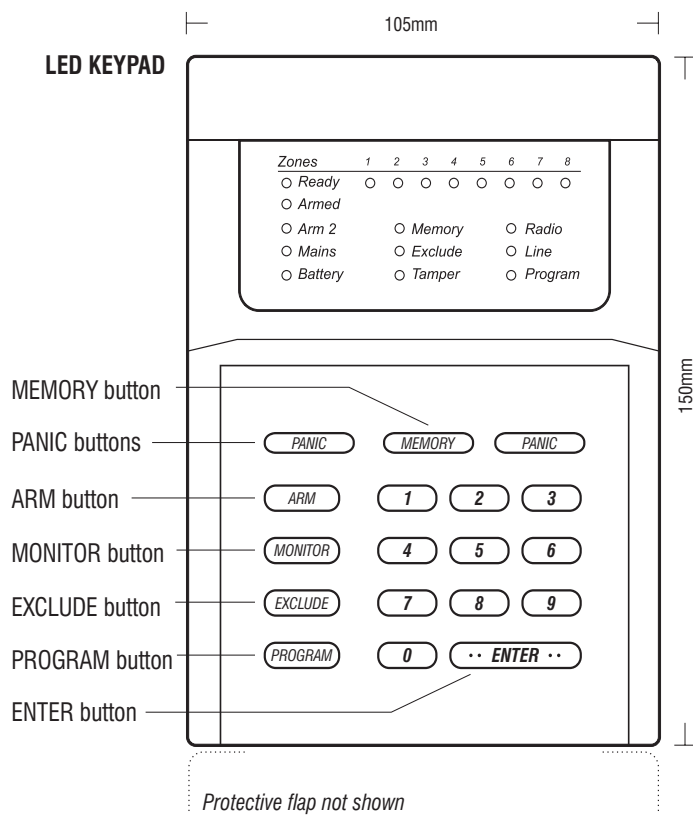

\* The "Not Ready" light is on when the panel is not ready to arm. i.e. a zone is unsealed, there may still be movement in the premises or a door or window left open

**KEYPAD BEEPER SOUNDS**













LED keypad and LCD keypad

<b>Each key press</b>	♪ 1 beep
<b>Valid command</b>	♪♪♪ 3 beeps
<b>Error</b>	♪— 1 long beep
<b>Mains power is off or Panel battery is low</b>	♪— 10 — 10 beeps

Keypad beeper sounds for LED or LCD keypad.

## KEYPAD INDICATORS

### KEYPAD LIGHTS IN NORMAL OPERATING MODE

LED KEYPAD	LCD KEYPAD	● OFF	○ ON	☀ FLASHING
<b>ZONES 1~8 or 1~16</b>		Zone is sealed	Zone is unsealed	Zone alarm
○ <b>READY</b>	 READY	Zone is unsealed, or Power fault or System is Armed, or phone line fault	Ready to Arm	
○ <b>ARMED</b>	 1 ARMED	Disarmed	Armed (AREA 1)	Monitor mode (LED Keypad only)
○ <b>ARM2</b>	 2 ARM2	Disarmed	Armed (AREA 2)	
	 MONITOR	Disarmed	Monitor mode	
○ <b>MAINS</b>	 MAINS	Normal		Mains power is off
○ <b>BATTERY</b>	 BATTERY	Normal		The panel's backup battery is low
○ <b>MEMORY</b>	 ALARM MEMORY	Normal	Memory mode selected	New alarms in memory
○ <b>EXCLUDE</b>	 EXCLUDE	Normal		Zones are excluded
○ <b>TAMPER</b>	 TAMPER	Normal		Tamper alarm
○ <b>RADIO</b>	 RADIO	Normal	Receiving radio signal	Indicates that a radio key or other radio device has a low battery
○ <b>LINE</b>	 LINE	Normal	Dialler is on line	Phone line fault or failure to communicate
○ <b>PROGRAM</b>	 PROGRAM	Normal	User Program mode	Installer program mode
	<b>Not Ready</b> 	Ready to Arm	Not ready to arm	

See page 16 for keypad indicators in Memory mode.

**This section describes the operation of a typical control panel installation. Keep in mind that your installation may vary depending on the selected options and equipment. The operating instructions which follow will cover the most common options.**

**Consult your installation company if you require further information.**

All control panel operations are controlled by the keypad except if an optional key switch, radio remote control or access control equipment is installed.

### **OPERATING RULES**

Generally, the panel will be disarmed. Armed or Monitor modes provide different levels of security for your premises when you are home or away. Three other temporary modes; Program, Memory and Exclude, allow you to perform various operations. The panel will automatically exit from these temporary modes if you do not press any buttons on the keypad in a four minute period.

If you make a mistake while entering any codes, press the Enter or E button and start again.

When you are required to enter your access code, you are given five opportunities to enter it correctly. After the fifth invalid attempt the alarm is activated (requiring the correct code + E to silence the alarm). This prevents anyone trying to guess your code by entering random numbers.

### **AREA PARTITIONING**

Area partitioning allows the zones to be split into two partitions; Area 1 and Area 2.

The panel then effectively operates as two separate systems sharing only the siren outputs and dialler.

### **USER CODE ASSIGNMENT**

A user code assigned to an area can arm and disarm only that area. User codes assigned to both areas will operate both Areas simultaneously.

### **COMMON AREA ZONES**

Zones assigned to both areas are armed only when Area1 and Area 2 are both armed. This allows the common area zone/s to be shared by both areas.

For example, office A and office B operate as separate areas but the entrance foyer, used by both offices, is assigned to both areas meaning it will automatically arm when both areas have armed. The common area then automatically disarms when either Area 1 or Area 2 disarms.

### **AREA OPERATION**

Arming and disarming is carried out as normal from a single keypad or separate keypads installed in both areas or by radio key.

Area operation only applies to zones when they are in the armed state. This means that Day, 24hr and Monitor zones are independent of the area operations.

Note: Area partitioning is in addition to Monitor mode. Any zone may be allocated to any area.



**LCD KEYPAD**

The LCD keypad uses a large illuminated LCD display to show system and zone status. The large easy to read buttons are backlit and a hinged flap covers the keys. The LCD icon display provides information on zone condition, armed state, mains and battery condition and other information.

Supplied with the 5400 and the 5400/16CB panel. Also available separately. Part Number 5412KP.



**LED KEYPAD**

The LED keypad has large backlit buttons for easy operation and a hinged flap to cover the keys when not in use. LED indicators show the condition of the zones, armed state, mains and battery and other information.

Part number 5410KP.



5403BP  
3 Button  
Radio Key



5404BP  
4 Button  
Radio Key

**CLIPSAL RADIO KEYS**

The optional Clipsal radio keys give you the convenience of remote control operation. Multi-button operation allows you to arm, disarm and activate PANIC.

The 5404BP Radio Key can also be programmed by your installer to activate an auxiliary output on the control panel.



5400ACR  
Access Reader  
Head Unit

**CLIPSAL ACCESS CONTROL**

5400 and 5400/16CB also have an access control option for arming/disarming and controlling electric door locks.

The panels have built-in software and hardware support for up to 3 Clipsal Weigand proximity card readers and up to 55 proximity cards or fobs.

Weigand reader. Part number 5400ACR.



Proximity card part number 5400RWC.

Proximity key fob part number 5400FB.

**Note:** Radio keys and access Cards and readers are optional and are not supplied with any HomeSafe control panel as standard. Clipsal radio products require a Clipsal radio interface to be fitted to the control panel.

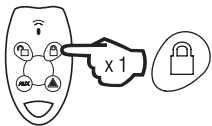

TO ARM THE PANEL

by <b>KEYPAD</b>	by <b>RADIO KEY</b>	by <b>ACCESS CARD</b> or <b>FOB</b>
Press <b>ARM</b> + <b>E</b> (If the <b>ARMING SHORTCUT</b> is enabled).		
or press <b>ARM</b> + <b>[USER CODE]</b> + <b>E</b>	Press the ON button once. The strobe light will flash briefly. If programmed, the external siren will <i>chirp</i> once.	
or press <b>[USER CODE]</b> + <b>E</b> (If <b>CODE ONLY ARMING</b> has been enabled by your installer).	(If Monitor Arming by radio key is enabled, the chirp will be delayed by 5 seconds).	Or, present a card or fob once + press button.  Depending on which option has been enabled by your installer.
The <b>ARMED</b> light will turn on. Leave the premises within the <i>Exit Delay Time</i> . 3 beeps will sound at the end of <i>Exit Delay Time</i> .		

\* On the LED keypad, the *Ready* light should be on. On the LCD keypad, the *Not Ready* light should be off.

The control panel must be armed in order to detect intruders.

Before arming, all zones should be sealed by making sure there is no movement in rooms protected by motion detectors. Doors or windows protected by reed switches should be closed.

The panel cannot be armed if in Program, Monitor, Memory or Exclude modes or if it is in alarm. (User codes that are programmed to be **ARM ONLY** codes can arm the panel either the disarmed state or from Monitor mode.

A keypad is supplied with the panel. Operation by radio keys and access cards is optional.

♪  10 beeps when you arm means mains power is turned off or the backup battery is low.



♪  One long beep when you arm could mean the panel is already armed or the keypad code is wrong, (if not using shortcut arming).

**SIREN WARNING:**

At the end of the exit time, all zones should be sealed. If any are unsealed, the siren will sound for 2 seconds to indicate that those zones have been automatically excluded. You should disarm the panel, check the premises and then arm again. Continual warnings could mean there is a problem with a detection device - that zone may have to be manually excluded.

If a zone is unsealed at the end of exit time and the auto-exclude option is disabled, the siren will sound for the duration of siren time, (default is 5 minutes).

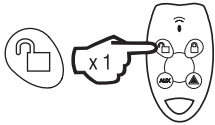
# OPERATION

to DISARM		
by KEYPAD	by RADIO KEY	by ACCESS CARD or FOB
<ul style="list-style-type: none"> <li>• Enter the premises through a Delay zone.</li> <li>• Press [USER CODE] + <b>E</b></li> <li>• The ARMED light will turn off.</li> </ul>	 <p>Press the OFF button once.</p> <p>The strobe light will flash briefly.</p> <p>If required, your installer can program the external siren to <i>chirp</i> 3 times when disarming.</p>	 <p>Present a card or fob once. (if the installer has enabled disarming by access card).</p>

When you enter the protected premises through a delay zone, the keypad responds with regular beeps<sup>1</sup> as a reminder to disarm. You then have your programmed entry delay time to disarm the panel.

If the panel is not disarmed by the end of the entry delay time, an alarm will occur.

By using the optional radio keys you may disarm your system from within your premises or from outside your entrance door. There is also the option to 'chirp' the outside siren three times and briefly flash the strobe light to indicate that you have disarmed your system.

If you make a mistake when entering your keypad code, then you must press E (or Enter) and start again. Five incorrect entries will cause an alarm.

The panel can be reset and the siren/s silenced by disarming the panel.

If you arrive at your premises and find the strobe light flashing<sup>2</sup> (if installed), reset the panel as above. To check the cause of the alarm, you can view the alarms in memory by entering Memory mode.

## Note: Arm Only codes

User codes can optionally be programmed to be *Arm Only* codes. An *Arm Only* code can arm the system but it cannot disarm. However if an *Arm Only* code is assigned to a radio key, the radio key OFF button will arm and disarm.

<sup>1</sup> If entry beeps are enabled.

<sup>2</sup> In the event of an alarm, the strobe light will flash for 72 hours or until the panel is reset.

to arm **MONITOR** Mode

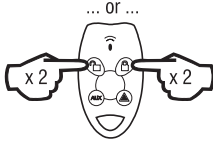
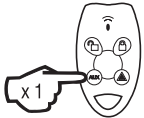
by <b>KEYPAD</b>	by <b>RADIO KEY</b>	
Press <b>MONITOR</b> + <b>E</b> (If the <b>MONITOR SHORTCUT</b> is enabled).	Monitor arming by radio key must be enabled by your installer.	
or press <b>MONITOR</b> + [USER CODE] + <b>E</b>	 <p>Press either the <b>OFF</b> button or the <b>ON</b> button twice within 4 seconds.</p>	 <p>Or press the <b>AUX</b> button once. (RK4 radio key only).</p>
	<p>The strobe light will flash briefly.</p> <p>If required, your installer can program the external siren to <i>chirp</i> twice when arming Monitor mode.</p>	

Monitor mode allows you to arm selected zones while others are ignored. Typically, perimeter zones (doors and windows) can be monitored while you are at home.

Your installer must program which zones will be active in Monitor mode.

If an alarm occurs while in Monitor mode, entering [User Code] **E** will silence the alarm. This will also disarm the panel, so remember to enter monitor again if needed.

Using the optional radio keys you can enter Monitor mode by pressing either the **OFF** button or the **ON** button twice within 4 seconds or by pressing the **AUX** button, (5404BP radio key only). These options must be enabled by your installer.

**Note: Monitor and Area arming**

Monitor mode can be used if the panel is fully disarmed or if only Area 2 is armed. Monitor mode is not available when Area 1 is armed.

The panel can be armed in Monitor mode if Area 2 is already armed on these conditions:

- Area 1 must be **OFF**.
- Area 2 must be armed first, and then Monitor armed – in that order.
- Zones assigned to both Monitor mode and to Area 2 will act as Monitor zones when both Area 2 and Monitor are armed.

Note: Monitor arming when Area 2 is armed cannot be done by radio key or by keyswitch.

## OPERATION

### PANIC alarm

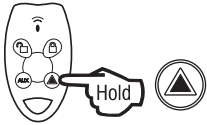
by KEYPAD	by RADIO KEY
Press <b>*</b> <b>*</b> star keys together.	 <p>Press and hold the PANIC button for at least 4 sec.</p>
or press <b>*</b> + [USER CODE] + <b>E</b>	
or press <b>*</b> + <b>E</b> (If KEYPAD PANIC SHORTCUT is enabled).	

The keypad Panic function may have been programmed to be either Audible to activate the sirens, or Silent to send a Panic report by dialler if your system is monitored by a central station.

Panic cannot be used while the panel is in Program, Memory or Exclude modes.

Note: Your installer may have installed a separate Panic button. To activate the panic alarm simply press that button.

### Keypad DURESS alarm

by KEYPAD
Press [5, 6, 8 OR 9]+[USER CODE] + <b>E</b>
Add one of these digits in front of a user code when disarming.
This sequence will disarm the panel and send a Duress report by dialler if the system is monitored by a central station.

The Duress arm can be used to send a silent alarm to the central station that you are being forced to disarm the panel against your will. That is; you are disarming under “duress.”

To disarm and send a Duress alarm, prefix your user code with one of the digits 5, 6, 8 or 9 when disarming.

\* THE KEYPAD DURESS IS NORMALLY NOT ENABLED. TO ENABLE THIS FUNCTION, CONSULT YOUR INSTALLER.

\* DURESS ALARMS CAN ONLY USED BY SYSTEMS WHICH ARE MONITORED BY A CENTRAL STATION.

\* THE DURESS ALARM CAN BE PROGRAMMED TO SOUND THE INTERNAL SIREN (RESET OUTPUT). THIS OPTION IS OFF BY DEFAULT.

**Keypad MEDICAL alarm****by KEYPAD**Press **2** + **E**

Sends a medical alarm report by dialler.

*(If this option has been enabled by your installer and the system is monitored by a central station).*

The medical alarm does not sound the sirens.

**Keypad FIRE alarm****by KEYPAD**Press **3** + **E**

Sounds the siren using the fire alarm sound.

*(If keypad fire alarm has been enabled by your installer).*

And sends a fire alarm report by dialler.

*(If this option has been enabled by your installer and the system is monitored by a central station).*

### How to **EXCLUDE** zones

#### by **KEYPAD**

Press **EXCLUDE** + **E**

(If the **EXCLUDE SHORTCUT** is enabled)

or press **EXCLUDE** + [USER CODE] + **E**

The Exclude light will turn on.

Then press [ZONE No.] + **E** [ZONE No.] + **E** (Enter the zone number/s to be excluded.)

Then press **E** to exit Exclude mode.

The Exclude light flashes constantly while zones are excluded. Excluded zones are automatically included next time the panel is disarmed.

If there is a problem with a detection device and the zone cannot be sealed when arming the panel, then that zone can be excluded so that it does not generate alarms.

When zones have been excluded, the exclude light flashes continuously while the panel is Disarmed and also when armed.

Zones can be excluded while the panel is either disarmed or armed. See notes below.

Zone exclude is not permanent. Excluded zones are automatically included next time the panel is disarmed.

Zones can be manually included by the same method as excluding. Simply use the [ZONE No.] + **E** sequence to turn OFF the zone lights to be Included.

#### NOTES

- **EXCLUDE E** works only when the panel is disarmed.
- **EXCLUDE [User Code] E** works in any state.
- **EXCLUDE [User Code] E** can only exclude the zones in the area assigned to that code.

## Viewing the EVENT MEMORY

by **KEYPAD**

Press **MEMORY** + **E** (If the VIEW MEMORY SHORTCUT is enabled).

or press **MEMORY** + [USER CODE] + **E**

*The Memory light will turn on.*

Press **MEMORY** ...The most recent event will be displayed.

Press **MEMORY** ...The next most recent event will be displayed.

Press **MEMORY** ...and so on, up to 30 events.

Press **E** to exit Memory mode.

The panel stores a comprehensive event memory, including arming, disarming, low battery, mains fail and alarm events.

The memory is constantly upgraded and the last 30 events are always available for viewing.

This memory display can only be selected while the panel is in the disarmed state.

### TO CLEAR THE MEMORY LIGHT

The Memory light flashes continuously when an alarm has occurred as a reminder to view the alarm memory. The Memory light stops flashing after the memory is viewed as shown above.

**The Memory light is automatically cleared next time the panel is armed.**

## OPERATION

When reviewing the event memory, the keypad lights will show the stored events as shown on this table.

<b>MEMORY MODE - EVENTS INDICATED BY KEYPAD LIGHTS:</b>	
<b>INDICATOR ON THE KEYPAD</b>	<b>MEMORY EVENT</b>
Zone lights 1–8 or 1–16	Zone alarm
(no lights)	Panel disarmed
ARMED	Panel armed (or Area 1 armed)
ARM2	Area 2 armed
MAINS	Mains power failure
BATTERY	Low battery
TAMPER	Tamper alarm (siren cover, panel etc)
EXCLUDE	Panic alarm
LINE	Telephone line fail
RADIO, EXCLUDE	Radio key panic alarm
RADIO, BATTERY, ZONE	Radio device battery low, (Device number is indicated by a zone light)
RADIO, BATTERY, ARM	Radio key battery low, (Radio key number is NOT indicated)
RADIO, TAMPER, ZONE	Radio device tamper alarm, (Device number indicated by a zone light)
(LCD Keypad) RADIO, MONITOR, ZONE (LED Keypad) RADIO, ZONE	Radio supervision fail (Device number indicated by a zone light)
MONITOR, ZONE	Wired zone supervision fail (Zone indicated by a zone light)



The Clipsal 5400 and 5400/16CB have a Temporary Day zone feature which allows easy and flexible Day Zone selection and operation.

Temporary Day zones operate in addition to Permanent Day zones which are usually setup by the installer.

While remaining in normal operating mode, the user can add and remove 'Temporary Day' zones.

As an extra feature, the user can easily enable or disable Day mode, (which includes both Temporary and Permanent Day zones).

Day zones can be programmed by your installer to beep the keypad, or briefly sound the siren/s or flash the strobe light, or to sound an optional buzzer. (Although the keypad beeper provides sufficient warning in most situations).

## TYPICAL APPLICATIONS

Day zones are useful for a variety of applications such as a shop door beeper, triggered by a reed switch on the door.

For example, in a shop you could enable Day mode to alert you when a customer enters the front door.

You can also enable additional Temporary Day zones to monitor switches on, for example, the rear door or the fridge doors.

## COMMANDS

(Accessed from normal operating mode).

ENTER SELECTION MODE.

**(P) + (E)**

Press **P** followed by **E** when in operating mode to enter Temporary Day zone selection mode.

ZONE SELECTION.

**[Zone No.] + (E)**

To select or deselect zones to be Temporary Day zones. The selected zones are indicated by the corresponding zone number.

Permanent Day zones, (installer option P53E), are not displayed in selection mode. Permanent Day zones can be selected as Temporary Day zones but this has no effect as those zones are already Day zones.

EXIT SELECTION MODE.

**(E)**

Saves changes and returns to normal operating mode.

ENABLE DAY MODE.

**(O) + (E)**

This enables/disables both Temporary and Permanent Day zones.

When Day mode is enabled, any unsealed day zone will sound the programmed output for 2 seconds. When Day mode is disabled, an unsealed Day zone will simply be indicated on the keypad as an unsealed zone.

(Note: The keypad does not indicate if Day mode is enabled or disabled).

## TEMPORARY DAY ZONES

### EXAMPLE

An example of how to select zones 1, 2 & 3 as Temporary Day zones.

Note that Permanent Day zones which have been programmed by the installer cannot be deselected by this method. However, the user can disable Day mode using the **0+E** command.

#### TO ENTER SELECTION MODE

Press **P** + **E**

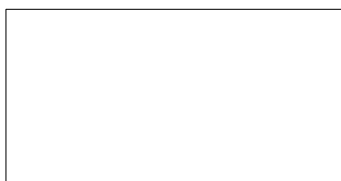

The display will go blank.

#### TO SELECT TEMPORARY DAY ZONES

Example, to select zones 1, 2 & 3.

Press **1** + **E**

**2** + **E**

**3** + **E**

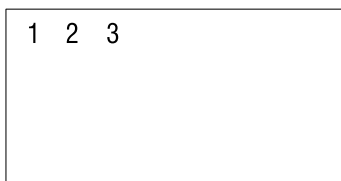

Zone icons 1,2 & 3 will be on.

#### TO EXIT SELECTION MODE

Press **E**



The display will show the normal operating mode. (Various zone icons may be on or off depending on which detectors are sensing movement).

#### TO ENABLE DAY MODE

This command enables or disables Day mode. This affects Permanent and Temporary Day zones.

Press **0** + **E**



The display will NOT indicate if Day mode is enabled.

Programming your Clipsal 5400 or 5400/16CB is a simple process using the keypad.

To enter program mode you need to know your master code, which is user code number 1, (see the table on the next page).

If you forget your master code it can be reset by your installer.

**USER CODES**

The panel has 56 user codes which can be operated by keypad code (3-6 digit PIN), by optional radio key or by optional access cards.

To add, change or delete a keypad code, follow the steps on page 22.

The panel is supplied with the master code pre-programmed as 123. You should re-program this code with a new code of your own choice.

**TIMERS**

You can also re-program the entry delay time and exit delay time if you need more or less time to exit and enter the premises.

**TELEPHONE NUMBER**

If your panel is programmed for audible monitoring, the panel's dialler will make alarm calls to the primary and Secondary telephone numbers programmed by your installer.

If a 'follow me' telephone number is programmed, the primary and secondary telephone numbers will be ignored. All alarm calls will be sent to the 'follow me' telephone number. This is handy if you, for example, stay at a relative's house overnight and you want the panel to call you there in the event of an alarm. When you delete the 'follow me' telephone number, alarm calls will again be made to the primary and secondary telephone numbers.

If your panel is monitored by a Central Station, the follow me number is ignored.

For all other programming changes, talk to your installer.

The factory default master code is: **123**

**To enter PROGRAM MODE**

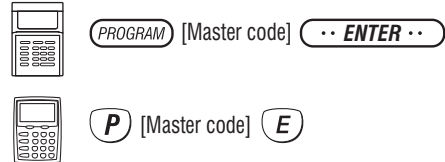

THE PANEL WILL AUTOMATICALLY EXIT PROGRAM MODE IF THE KEYPAD IS INACTIVE FOR 4 MINUTES.

**To exit PROGRAM MODE**

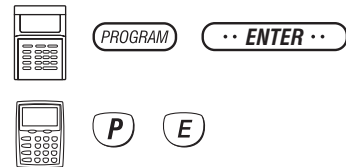

## PROGRAMMING OPTIONS TABLE

USER CODE	OPTION NO.	KEYPAD PIN
1 (Master Code)	P201E	123
2	P202E	
3	P203E	
4	P204E	
5	P205E	
6	P206E	
7	P207E	
8	P208E	
9	P209E	
10	P210E	
11	P211E	
12	P212E	
13	P213E	
14	P214E	
15	P215E	
16	P216E	
17	P217E	
18	P218E	
19	P219E	
20	P220E	
21	P221E	
22	P222E	
23	P223E	
24	P224E	
25	P225E	
26	P226E	
27	P227E	
28	P228E	

USER CODE	OPTION NO.	KEYPAD PIN
29	P229E	
30	P230E	
31	P231E	
32	P232E	
33	P233E	
34	P234E	
35	P235E	
36	P236E	
37	P237E	
38	P238E	
39	P239E	
40	P240E	
41	P241E	
42	P242E	
43	P243E	
44	P244E	
45	P245E	
46	P246E	
47	P247E	
48	P248E	
49	P249E	
50	P250E	
51	P251E	
52	P252E	
53	P253E	
54	P254E	
55	P255E	
56	P256E	

OPTION NO.	DESCRIPTION	DEFAULT	COMMENT
P26E	Entry Delay Time 1	20 (20 sec)	
P27E	Entry Delay Time 2	6 (60 sec)	This option works in multiples of 10. (6 = 60 sec).
P28E	Exit Delay Time	60 (60 sec)	
P00E	Follow Me Phone No.	blank	

Programming **USER CODES**

STEP	KEYSTROKES	DESCRIPTION	COMMENT
1	(P)+[MASTER CODE]+(E)	Enters user program mode.	The program light will turn on.
2	(P)+[OPTION No.]+(E)	Enter the 3 digit option number for the user code being programmed.	The existing user code, if any, will be displayed by the keypad one digit at a time.
3	[NEW CODE]+(E) [NEW CODE]+(E)	Enter the new user code twice for verification. Keypad codes can be 3-6 digits long.	The new user code will be displayed by the keypad one digit at a time.
4	(P) + (E)	To exit user program mode.	The program light will turn off.

A keypad code can be deleted by pressing (MEMORY) + (E) at STEP 3 above.

**i** A keypad code only needs to be deleted if you're not replacing it with a new code.

**EXAMPLES**

The panel must be in program mode.

- To program user code 1 to be 1234: Press P201E 1234 E 1234 E
- To delete user code 2 without programming a new code: P202E MEMORY E

**USER CODE PROGRAMMING RULES:**

- Up to 56 keypad codes can be used at up to three wired keypads for controlling all panel functions including arming/disarming, monitor mode, panic, memory recall and much more.
- Keypad codes can be 3 to 6 digits in length and can be individually programmed and deleted.
- User code 1 is also the master code which is used to enter client program mode.
- All 56 user codes are keypad codes by default. User codes can be programmed to be radio codes or access cards as required.

**NOTES**

1. Keypad codes beginning with 0 (zero) can be programmed but they will not operate the panel. This is an alternative method for disabling user codes.
2. All codes must be unique to each other. Codes are rejected if already used. Some codes that are similar to existing codes may also be rejected.
3. When re-programming a keypad code, the old code does not need to be deleted first. The new code will overwrite the old code.

## PROGRAMMING

Programming <b>TIMERS</b>			
STEP	KEYSTROKES	DESCRIPTION	COMMENT
1	$\text{(P)} + [\text{MASTER CODE}] + \text{(E)}$	Enters user program mode.	The program light will turn on.
2	$\text{(P)} + \text{(2)} \text{(6)} + \text{(E)}$  ...or $\text{(P)} + \text{(2)} \text{(7)} + \text{(E)}$  ...or $\text{(P)} + \text{(2)} \text{(8)} + \text{(E)}$	Enter the option number for entry delay time 1.  Or enter the option number for entry delay time 2.  Or enter the option number for exit delay time.	The existing time, if any, will be displayed by the keypad one digit at a time.
3	$[\text{NEW TIME}] + \text{(E)}$	Enter the new time in seconds. Example, enter 25 seconds as 25 + E.	The new time will be displayed by the keypad one digit at a time.
4	$\text{(P)} + \text{(E)}$	To exit user program mode.	The program light will turn off.

See page 21 for the entry and exit delay factory default settings.

Programming the <b>FOLLOW ME TELEPHONE NUMBER</b>			
STEP	KEYSTROKES	DESCRIPTION	COMMENT
1	$\text{(P)} + [\text{MASTER CODE}] + \text{(E)}$	Enters user program mode.	The program light will turn on.
2	$\text{(P)} + \text{(0)} \text{(0)} + \text{(E)}$	Enter the option number for follow me telephone number.	The existing telephone number, if any, will be displayed by the keypad one digit at a time.
3	$[\text{NEW TELEPHONE NUMBER}] + \text{(E)}$	Enter the new telephone number.	The new telephone number, if any, will be displayed by the keypad one digit at a time.
4	$\text{(P)} + \text{(E)}$	To exit user program mode.	The program light will turn off.

The 'follow me' telephone number is only used in audible dialling mode. If the 'follow me' number is programmed, then the primary & secondary numbers are ignored. Ask your installer for further information.

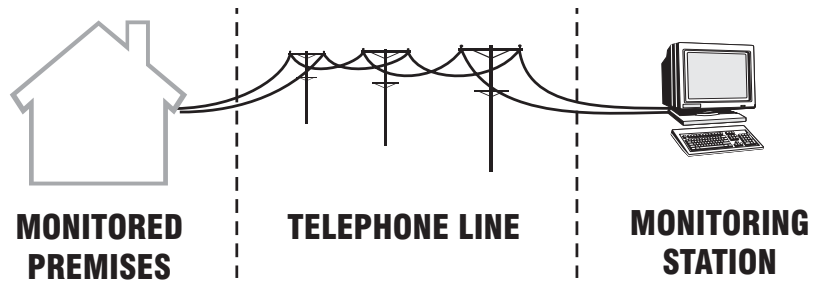

**CENTRAL STATION MONITORING**

The 5400 and 5400/16CB control panels have an on-board digital dialler which can send detailed alarm messages to a central monitoring station.

The digital messages can include information about the zone or zones which caused the alarm, tamper alarms, low battery or mains failure reports, and it can also (by user number) identify the users who arm and disarm the system.

Central station monitoring is highly recommended and is the most effective method of monitoring your alarm system.

For further information about 24 hour monitoring, contact your installer or Clipsal Integrated Systems.

## MONITORING

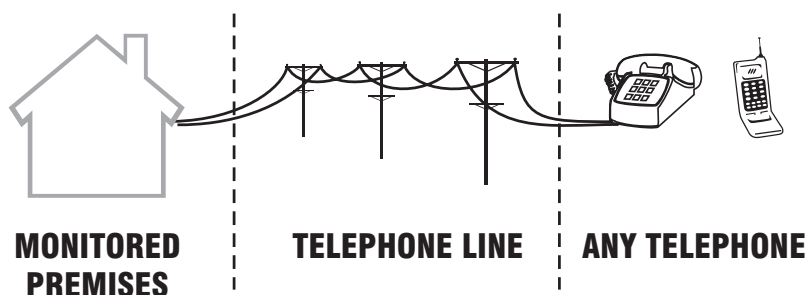

### AUDIBLE MONITORING

As a lower security alternative to central station monitoring, the panel can be programmed to send audible messages to a fixed or mobile phone.

When programmed for audible monitoring, the panel calls a pre-programmed number (or numbers) and sounds a series of beeps over the phone. These beeps can identify the zone or zones which caused the alarm and well as several other alarm types.

### 'FOLLOW ME' TELEPHONE NUMBER

If your panel is programmed for audible monitoring, the panel's dialler makes alarm calls to the primary and secondary telephone numbers programmed by your installer.

If a 'follow me' telephone number is programmed, the primary and secondary telephone numbers will be ignored. All alarm calls will be sent to the 'follow me' telephone number.

If your Clipsal panel is monitored by a central station, the 'follow me' number is ignored.

### AUDIBLE MONITORING SEQUENCE

When triggered by an alarm, the panel will dial the programmed telephone number/s and output the audible message for 45 seconds or until it is acknowledged.

### ACKNOWLEDGING THE ALARM

The person receiving the call can then acknowledge the alarm by pressing the **#** key on their telephone. Press the **#** key for at least 2 seconds during pauses in the audible message.

(On mobile phones, press the **#** key in short bursts. Many mobile phones enter sub menus if the **#** key is pressed continuously).

If the alarm is not acknowledged, the keypad's line light will flash continuously until the panel is next armed.



The 5400 and 5400/16CB will allow a user to call in to the panel, using a standard DTMF telephone, and remotely Arm or Disarm all areas and also turn on or off AUX outputs 1, 2, 3 or 4.

To maintain panel security, remote operations can only be activated after entering a valid user code.

To operate the panel by telephone, you need a DTMF capable telephone, a valid user code and you must know the telephone number of the line to which the panel is connected.

### NOTES



- If the panel does not receive commands for periods longer than 10 seconds it will assume that the call is finished and it will hang up.
- If an alarm occurs which requires the panel to dial out while attempting remote control, the panel will treat the alarm as a priority, give a constant tone as a warning and then hang up.
- When all remote control commands are finished press **\* #** to force the panel to hang up.

### SEQUENCE OF OPERATION

1. Phone the panel telephone number and listen for the required number of rings and then hang up.
2. Wait 10 seconds and then call the number again within 50 seconds.
3. The panel will answer the second call immediately, sound a beep for 2 seconds then, after a pause, it will sound a lower frequency tone. The panel is now ready to receive telephone commands.
4. Press the **0** button on the telephone. This tells the panel that telephone commands will follow. The panel will respond with 3 beeps if all OK (one long beep means try again).
5. Now enter a valid user code (that is normally used for arming or disarming the panel) followed by the **#** button.  
  
The panel will respond with 3 beeps if it recognises the code or 1 long beep to signal the code was invalid and to try again.
6. Enter the required command. See the summary of telephone commands on the next page.
7. Press **\* #** to finish. This tells the panel to hang up. Also hang up your telephone.

## REMOTE OPERATION

### AUDIBLE FEEDBACK



 3 beeps	<ul style="list-style-type: none"><li>• The user code is valid</li><li>• Successful arming or disarming</li><li>• An auxiliary output has been turned ON.</li></ul>
 1 long beep	<ul style="list-style-type: none"><li>• Panel is already armed</li><li>• Invalid code. Try again.</li></ul>
 1 short beep	<ul style="list-style-type: none"><li>• An Auxiliary output has been turned OFF.</li></ul>

### SUMMARY OF TELEPHONE COMMANDS

<b>0</b>	Prepare to receive commands
<b>1</b> <b>#</b>	Arm areas
<b>2</b> <b>#</b>	Disarm areas
<b>3</b> <b>#</b>	Turn Aux 1 Output ON or OFF
<b>4</b> <b>#</b>	Turn Aux 2 Output ON or OFF
<b>5</b> <b>#</b>	Turn Aux 3 Output ON or OFF
<b>6</b> <b>#</b>	Turn Aux 4 Output ON or OFF
<b>*</b> <b>#</b>	Finished – hang up

---

### EXAMPLE: ARMING THE PANEL BY TELEPHONE

1. Dial the panel telephone number. Listen for one double ring then hang up.
2. Wait 10 seconds, then dial the telephone number again.  
*The panel will answer immediately and gives a 2 second beep followed by a low tone.*
3. PRESS **0** To prepare the panel ( 3 beeps)
4. PRESS **[User code]** **#** to authorise the next command ( 3 beeps)
5. PRESS **1** **#** to arm the panel ( 3 beeps)
6. PRESS **\*** **#** to finish and hang up

SYMPTOM	POSSIBLE CAUSE	REMEDY
When arming, a zone light is on or the keypad gives a long beep.	One or more detection device (a PIR or reed switch) may be <i>unsealed</i> .	Find the cause of movement or close the door or window.
<ul style="list-style-type: none"> <li>• 10 beeps from keypad.</li> <li>• MAINS light is flashing.</li> <li>• BATTERY light is flashing.</li> </ul>	The mains power may be off, or the panel's backup battery may be low, or a radio device battery may be low.	Make sure the plug pack is plugged in and the power point is turned on. The backup battery may need replacing, call your installer.
1 long beep from the keypad.	Invalid keypad entry.	Press the E button and try again.
2 second siren at the end of exit delay time.	A zone was <i>unsealed</i> at the end of exit delay time.	Disarm the panel and check all zones.
The strobe light is flashing.	There has been an alarm within the last 72 hours.	Reset the alarm by disarming the panel and check the alarm memory
Siren sounds while the panel is disarmed.	A 24 hour zone has been alarmed. (siren tamper, box tamper, panic button).	Reset the alarm by disarming the panel and call your installer.
EXCLUDE light is flashing.	A zone(s) has been excluded.	This is to indicate that one or more zones have been excluded.
Cannot arm and the EXCLUDE light is on steady.	You are in exclude mode.	Press E to exit exclude mode.
TAMPER light flashing.	The 24 hour tamper input has alarmed. (Siren tamper or box tamper).	Call your installer.
ALARM MEMORY light is flashing.	There are alarms in memory.	To clear the alarm memory light, view the alarm memory otherwise the light will clear next time you arm the panel.
Cannot enter program mode.	The panel is armed. Or you may be attempting to enter program mode using one of the user codes.	Disarm the panel before attempting to enter program mode. Try again using the master code.
When I arm by radio key, the armed light on the keypad does not turn on immediately.	The panel is waiting 5 seconds for a second press of the ON button to enter monitor mode.	This is normal operation when arming of monitor mode by radio key is enabled.

# INSTALLATION RECORD

## Clipsal HomeSafe

- 5400 ALARM CONTROL PANEL
- 5400/16CB ALARM CONTROL PANEL

DATE PURCHASED:	DATE INSTALLED:
INSTALLATION COMPANY:	
TELEPHONE:	
MONITORING COMPANY:	
TELEPHONE:	

### TIMERS

User programming options

- P26E ENTRY DELAY TIME 1  Seconds
- P27E ENTRY DELAY TIME 2  Seconds
- P28E EXIT DELAY TIME  Seconds
- P29E SIREN RESET TIME  Minutes

### ZONE ASSIGNMENT

Installer programming options

- P41E ENTRY DELAY 1
- P43E ENTRY DELAY 2
- P42E HANDOVER
- P40E INSTANT
- P45E AREA 1
- P46E AREA 2
- P51E MONITOR
- P52E 24 HOUR
- P54E RESET OUTPUT
- P55E STROBE OUTPUT
- P56E SONALERT OUTPUT
- P57E SIREN OUTPUT
- P74E Report (dialler)

ZONES	DEVICE TYPE	PIR, Reed switch, etc	DESCRIPTION	Entrance, bedroom1, etc	P41E	P43E	P42E	P40E	P45E	P46E	P51E	P52E	P54E	P55E	P56E	P57E	P74E	
D8 & D16	1																	
	2																	
	3																	
	4																	
	5																	
	6																	
	7																	
	8																	
D16	9																	
	10																	
	11																	
	12																	
	13																	
	14																	
	15																	
	16																	

USER CODE	OPTION No	Extra Options Assigned E.g. Radio Code, Arm Only, etc.
1 <small>Master Code</small>	P201E	
2	P202E	
3	P203E	
4	P204E	
5	P205E	
6	P206E	
7	P207E	
8	P208E	
9	P209E	
10	P210E	
11	P211E	
12	P212E	
13	P213E	
14	P214E	
15	P215E	
16	P216E	
17	P217E	
18	P218E	
19	P219E	

USER CODE	OPTION No	Extra Options Assigned E.g. Radio Code, Arm Only, etc.
20	P220E	
21	P221E	
22	P222E	
23	P223E	
24	P224E	
25	P225E	
26	P226E	
27	P227E	
28	P228E	
29	P229E	
30	P230E	
31	P231E	
32	P232E	
33	P233E	
34	P234E	
35	P235E	
36	P236E	
37	P237E	
38	P238E	

USER CODE	OPTION No	Extra Options Assigned E.g. Radio Code, Arm Only, etc.
39	P239E	
40	P240E	
41	P241E	
42	P242E	
43	P243E	
44	P244E	
45	P245E	
46	P246E	
47	P247E	
48	P248E	
49	P249E	
50	P250E	
51	P251E	
52	P252E	
53	P253E	
54	P254E	
55	P255E	
56	P256E	

Operation by KEYPAD	
<p>to ARM</p> <p>The panel must initially be disarmed.</p>	<p>Press <b>ARM</b> + <b>E</b></p> <p>(If the arming shortcut is enabled)</p> <p>or press <b>ARM</b> + [USER CODE] + <b>E</b></p> <p>or press [USER CODE] + <b>E</b></p> <p>(If Code Only Arming has been enabled for that user code)</p>
<p>to DISARM</p> <p>To disarm and/or reset alarms.</p>	<p>Press [USER CODE] + <b>E</b></p>
<p>to arm MONITOR MODE</p> <p>The panel must initially be disarmed.</p> <p>See page 20 for more information on arming Monitor Mode.</p>	<p>Press <b>MONITOR</b> + <b>E</b></p> <p>(If the MONITOR SHORTCUT is enabled)</p> <p>or press <b>MONITOR</b> + [User Code] + <b>E</b></p>
<p>PANIC alarm</p>	<p>Press both <b>*</b> <b>*</b> star keys together</p> <p>or press <b>*</b> + [USER CODE] + <b>E</b></p> <p>or press <b>*</b> + <b>E</b></p> <p>(If KEYPAD PANIC SHORTCUT is enabled)</p>
<p>KEYPAD DURESS</p> <p>Keypad Duress allows the user to send a silent duress report while disarming, (if the system is being monitored by a central station).</p>	<p>Press [5, 6, 8 OR 9]+[USER CODE] + <b>E</b></p> <p>Add one of these digits in front of a user code when disarming.</p> <p>This sequence will disarm the panel and send a Duress report by dialler to the central station.</p> <p>(REPORT KEYPAD DURESS must be enabled)</p>
<p>EXCLUDE ZONES</p> <p>EXCLUDE + E can only be used when the panel is disarmed.</p> <p>EXCLUDE + CODE + E can be used anytime.</p>	<p>Press <b>EXCLUDE</b> + <b>E</b> (If the EXCLUDE SHORTCUT is enabled)</p> <p>then [ZONE No.] + <b>E</b> [ZONE No.] + <b>E</b></p> <p>(Enter the zone number/s to be excluded.)</p> <p>then press <b>E</b> to exit Exclude mode.</p> <p>The Exclude light flashes constantly while zones are excluded.</p> <p>Excluded zones are automatically included next time the panel is disarmed.</p>

\* If a user code is assigned to a radio key and has Extra Option 4E enabled, (CODE ONLY ARMING), then pressing OFF toggles the panel arm/disarm state.

**Product of**

**Clipsal Integrated Systems Pty Ltd**

Member of Clipsal Australia Holdings Group

ABN 15 089 444 931

**Head Office**

12 Park Terrace, Bowden  
South Australia 5007

PO Box 103 Hindmarsh  
South Australia 5007

Telephone (08) 8440 0500  
International +61 8 8440 0500

Facsimile (08) 8346 0845  
International +61 8 8346 0845

Internet www.clipsal.com/cis  
E-Mail cis@clipsal.com.au

**CIS Technical Support Hotline:**

1300 722 247

**National Customer Service Enquiries:**

1300 2025 25

**National Customer Service Facsimile:**

1300 2025 56

**International Enquiries**

**International Sales and Marketing**

Telephone +61 8 8269 0587  
Facsimile +61 8 8340 7350  
E-Mail export@clipsal.com.au

**New Zealand**

Clipsal Industries (NZ) Ltd  
Telephone +64 9 576 3403  
Facsimile +64 9 576 1015  
E-Mail headoffice@clipsal.co.nz

**Customer Service**

Free Facsimile (0508) 250 305  
Auckland/Mobile Phone (09) 572 0014  
Free Phone (0508) CLIPSAL  
2547725

**Malaysia**

Clipsal Integrated Systems (M) Sdn Bhd  
Unit 3-2, Level 3, C P Tower  
No.11, Jalan 16/11, Seksyen 16,  
46350 Petaling Jaya, Selangor, Malaysia  
Telephone +60 3 7665 3555  
Facsimile +60 3 7665 3155  
E-Mail sales@cisasia.com.my

**Singapore**

Clipsal Integrated Systems Pte Ltd  
5, Fourth Chin Bee Road  
619 699 Singapore  
Telephone +65 6415 3232/3233  
Facsimile +65 6415 3289  
E-Mail sales@cisasia.com.sg

**International Representatives**

**China**

Clipsal China Limited  
Telephone +86 755 8237 5959

**Greece**

Schneider Electric AE  
Telephone +30 69 4646 3200

**Hong Kong**

Clipsal Integrated Systems (HK) Limited  
Telephone +852 2487 0261

**India**

Schneider Electric India Pvt Ltd  
Telephone +91 11 5159 0000

**Indonesia**

PT Clipsal Graha Nusa  
Telephone +62 21 630 6430

**Korea**

Clipsal Korea Co. Ltd  
Telephone +822 549 5550

**Pakistan**

Clipsal Pakistan (Pvt) Ltd  
Telephone +92 21 506 7278

**Philippines**

Clipsal Philippines Inc.  
Telephone +632 683 0275-78

**South Africa**

Clipsal South Africa (Pty) Ltd  
Telephone +27 11 314 5200

**Taiwan**

Clipsal (Taiwan) Co Ltd  
Telephone +886 2 2558 3456

**Thailand**

Clipsal Thailand Ltd  
Telephone +66 2 952 5338-42

**United Arab Emirates**

Clipsal Middle East  
Telephone +971 6 5570 777

**United Kingdom**

Clipsal Integrated Systems  
C/o Schneider Electric  
Telephone +44 870 608 8 608

**Vietnam**

Clipsal - VTEC  
Telephone +848 856 3002

You can find this brochure and many others online in PDF format at:

**clipsal.com**

Follow the links off the home page or access the following page directly:

**clipsal.com/wat\_lib\_pdf.cfm**

**clipsal.com/cis**

Clipsal Integrated Systems Pty Ltd reserves the right to change specifications, modify designs and discontinue items without incurring obligation and whilst every effort is made to ensure that descriptions, specifications and other information in this catalogue are correct, no warranty is given in respect thereof and the company shall not be liable for any error therein.

© Clipsal Integrated Systems Pty Ltd 2005.  
All rights reserved.

This material is copyright under Australian and international laws. Except as permitted under the relevant law, no part of this work may be reproduced by any process without prior written permission of and acknowledgement to Clipsal Integrated Systems Pty Ltd.